

FITTING INSTRUCTION

Clamp mark in acc. with		Cables joining
ISO	PN	
1	L	Left directional lights
2	+	Rear fog lights
3	31	Ground
4	R	Right directional lights
5	58R	Right side parking lights
6	54	Stoplights
7	58L	Left side parking lights

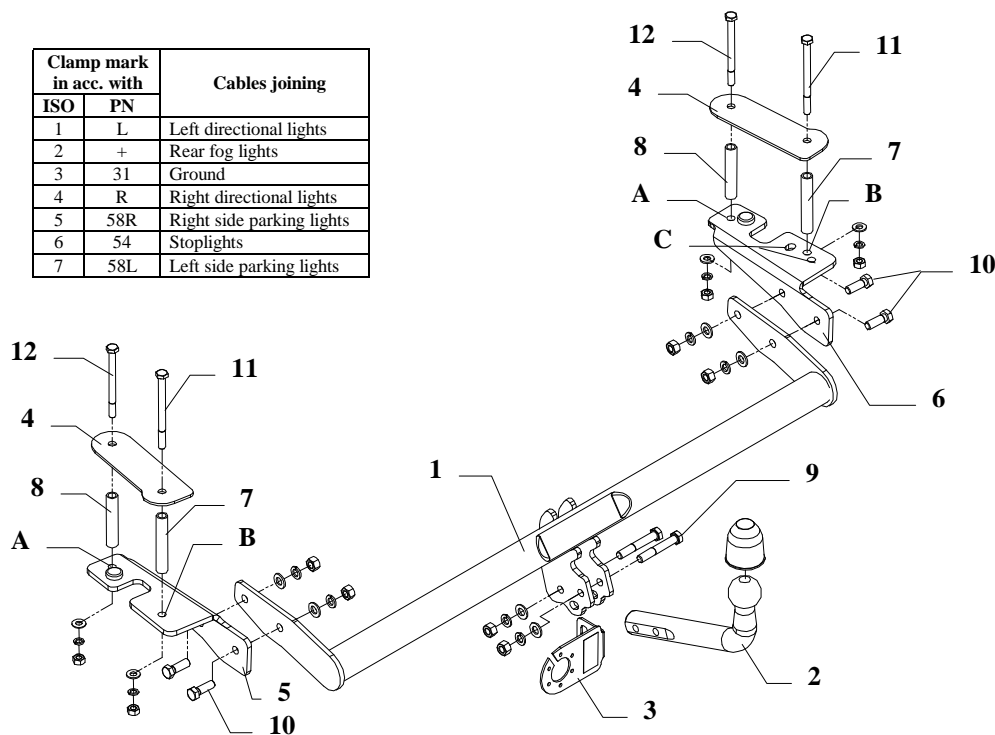

This towbar is designed to assembly in following cars:
FIAT PALIO WEEKEND (estate) produced since 2002, catalogue number **R31** and is prepared to tow trailers max total weight **1000 kg** and max vertical load **70 kg**.

From manufacturer

Thank you for buying our product. Their reliability has been confirmed in many tests. Reliability of towbar depends also on correct assembly and right operation. For this reasons we kindly ask to read carefully this instruction and apply to hints.

The towbar should be install in points described by a car producer.

Fitting instructions

1. Take a spare wheel out of a boot; disassemble an boot's upholstery (from a floor and a walls)
2. Disassemble a fabric towing eye (it is not used any more)
3. Put element (pos. 6) to the right chassis member (do it in such a way that a pin is compatible with a fabric holes and holes pos. C are compatible with a threaded holes. Fix it with bolts from the original towing eye.
4. Drill $\phi 10,5$ mm through holes (pos. A and B) of element pos. 6 to the inside part of the boot. Then enlarge this hole by a drill $\phi 17$ mm (do it only inside the boot). Next, slide a spacers L = 90 and 100 mm, as it shown a sketch, and fix it with bolts according to figure 2.
5. Position element (pos. 5) to the left chassis member (do it in such a way that a pin is compatible with a fabric holes), then position the element in such a way that its edge raze to an chassis member's edge (compare to the right side). Drill $\phi 10,5$ mm through the holes (pos. A and B) to the boot . Other activities like in point 5.
6. Slide main bar (pos. 1) between brackets (pos. 5 and 6 and fix it with M12x35mm bolts (pos. 10)
7. Position the ball of towbar (pos. 2) with socket plate (pos. 3) and fix with M12x75mm bolts (pos.9) from the towbar accessories.
8. Tighten all nuts and bolts according to the torque shown in the table
9. Connect the electric wires according to the instructions of the car
10. Complete the paint cover of towbar (during the mounting paint cover could be destroyed)

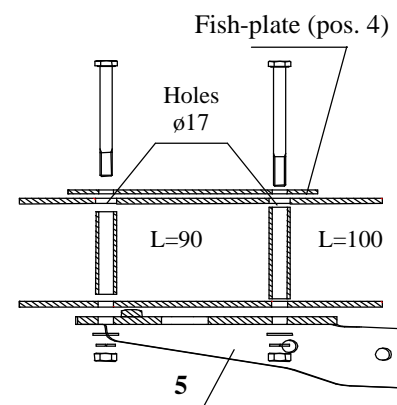

Fig. 2.
The way of side bracket assembly.











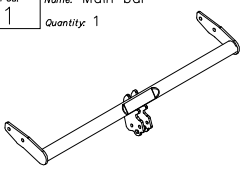
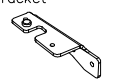

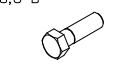

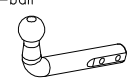
NOTE

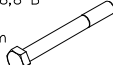
After install the towbar you should get adequate note in registration book (at authorised service station).The car should be equipped with:

- Indicators
- Tow mirrors

After 1000km check all bolts and nuts. The ball of towbar must be always kept clear and conserve with a grease.

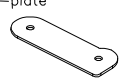
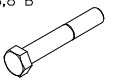
Towbar accessories:

Pos. 1 Name: Main bar Quantity: 1	Pos. 5 Name: Left bracket Quantity: 1	Pos. 10 Name: Bolt 8,8 B Quantity: 4 Dim.: M12x35mm	Pos. 15 Name: Plain washer Quantity: 6 Dim.: Ø 13 mm
	Pos. 6 Name: Right bracket Quantity: 1	Pos. 11 Name: Bolt 8,8 B Quantity: 2 Dim.: M10x130mm	Pos. 16 Name: Plain washer Quantity: 4 Dim.: Ø 10,5 mm
			
Pos. 2 Name: Tow-ball Quantity: 1	Pos. 7 Name: Distance sleeve Quantity: 2 Dim.: Ø17,2xØ2,35mm L=100mm	Pos. 12 Name: Bolt 8,8 B Quantity: 2 Dim.: M10x120mm	Pos. 17 Name: Spring washer Quantity: 6 Dim.: Ø 12,2 mm
			
Pos. 3 Name: Socket plate Quantity: 1	Pos. 8 Name: Distance sleeve Quantity: 2 Dim.: Ø17,2xØ2,35mm L=90mm	Pos. 13 Name: Nut 8 B Quantity: 6 Dim.: M12	Pos. 18 Name: Spring washer Quantity: 4 Dim.: Ø 10,2 mm
			
Pos. 4 Name: Fish-plate Quantity: 2	Pos. 9 Name: Bolt 8,8 B Quantity: 2 Dim.: M12x75mm	Pos. 14 Name: Nut 8 B Quantity: 4 Dim.: M10	Pos. 19 Name: Ball cover Quantity: 1
			

Torque settings for nuts and bolts (8,8):

M8	25 Nm	M10	55 Nm
M12	85 Nm	M14	135 Nm



PPUH AUTO-HAK S.J.

Produkcja Haków Holowniczych
Henryk & Zbigniew Nejman
76-200 SŁUPSK ul. Słoneczna 16K
tel/fax (059) 8-414-414; 8-414-413
e-mail: office@autohak.com.pl
www.autohak.com.pl

Towing hitch (without electrical set)

Class: **A50-X** Cat. no. **R 31**

Designed for:

Manufacturer: **FIAT**

Model: **PALIO WEEKEND**

Type: **ESTATE**

produced since 2002

Technical data:

D-value: 6,21 kN

maximum trailer weight: **1000 kg**

maximum vertical cup load: **70 kg**

Approval number acc. to regulations EKG/ONZ 55.01: **E20-55R-01 0775**

Certificate no. : **B/1/199/2000**

Foreword

This towbar is designed according to rules of safety traffic regulations. The towing hitch is a safety component and must be installed only by qualified personnel. Any alteration or conversion to the towinh hitch is prohibited and would lead to cancellation of design certification. Remove insulating compound and underseal from vehicle (if present) in the area of the matting surfaces of the towing hitch.

The vehicle manufacturer's specifications regarding trailer load and max. vertical cup load are decisive for driving, and values for the towing hitch must not be exceeded.

D-value formula:

$$\frac{\text{Max trailer weight [kg]} \times \text{Max vehicle weight [kg]}}{\text{Max trailer weight [kg]} + \text{Max vehicle weight [kg]}} \times \frac{9,81}{1000} = D \text{ [kN]}$$