

FITTING INSTRUCTION

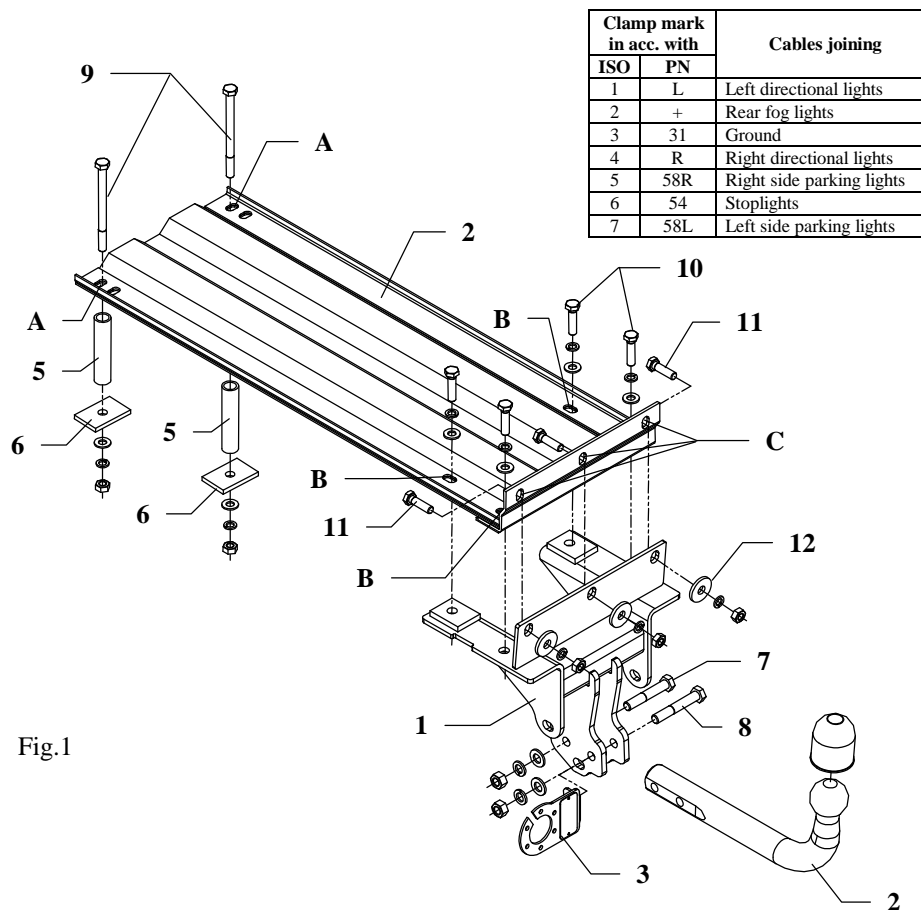

Fig.1

This towbar is designed to assembly in following car: **OPEL OMEGA „A” 4 doors**, produced since 1986 till 1993, catalogue number **E14** and is prepared to tow trailers max total weight **1850 kg** and max vertical load **75 kg**.

From manufacturer

Thank you for buying our product. Their reliability has been confirmed in many tests. Reliability of towbar depends also on correct assembly and right operation. For this reasons we kindly ask to read carefully this instruction and apply to hints.

The towbar should be installing in points described by a car producer.

The instruction of the assembly

1. Disassemble the bumper, take out carpet from boot, disassemble cover of rear part of car (from inside boot).
2. Inside boot find original marked points to towbar installation. To make this operation easily, put main plate pos. 3 into trunk and put to the rear part of car and drill holes (pos. A,B,C) using bit $\varnothing 10,5$ mm – in floor of trunk and in rear wall.
3. Fix main plate (pos. 2) with boot's floor using bolts M10x40mm (pos. 10) through holes pos. B.
4. Put distance sleeves (pos. 5) from below the car to holes A and fix with rectangular washer (pos. 6) using bolts M10x130mm (pos. 9).
5. Apply main bar of the towbar (pos. 1) outside to rear wall of the car and fix it with already installed main plate through holes pos. C using big washers (pos. 12), and 3 bolts M10x35mm (pos. 11).
6. Fix ball of towbar (pos. 2) together with socket plate (pos. 2) using bolt M12x75mm (pos. 8) and M12x70mm (pos. 7) as shown in figure.
7. Find original mark in central part of cover rear part of car, break them, then reassemble cover.
8. Tighten all bolts according to the torque shown in the table.
9. Reassemble rear bumper to the car.
10. Connect electric wires of 7-poles socket according to the instruction of the car. (Recommend to make at authorized service station)
11. Complete the paint coating damaged during installation.

Torque settings for nuts and bolts (8,8):

| | | | |
|-------------|-------|-------------|--------|
| M 8 | 25 Nm | M 10 | 55 Nm |
| M 12 | 85 Nm | M 14 | 135 Nm |











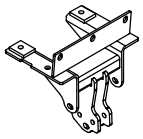

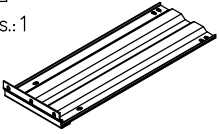
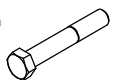

NOTE

After install the towbar you should get adequate registration in registration book (at authorised service station).The car should be equipped with:

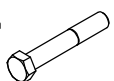
- Indicators
- Tow mirrors

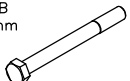
Check all bolts and nuts after 1000km of exploitation. The ball of towbar must be always kept clear and conserve with a grease.

Towbar equipment:

| | | | |
|---------------------------------------------------------------------------------------------------------------------|-----------------------------------------------------------------------------------------------------------------------------------------------------|-----------------------------------------------------------------------------------------------------------------------------------|-----------------------------------------------------------------------------------------------------------------------------------|
| Pos. 1 Main bar PCS.: 1  | Pos. 5 Distance sleeve ø21,3x2,65mm L=97mm PCS.: 2  | Pos. 11 Bolt 8,8 B M10x35mm PCS.: 3  | Pos. 17 Nut 8 B M12 PCS.: 2  |
| | Pos. 6 Rectangular washer 60x40x4mm PCS.: 2  | Pos. 12 Washer ø35xø12x4mm PCS.: 3  | Pos. 18 Nut 8 B M10 PCS.: 5  |
| Pos. 2 Main plate PCS.: 1  | Pos. 7 Bolt 8,8 B M12x75mm PCS.: 1  | Pos. 13 Plain washer ø12mm PCS.: 2  | Pos. 19 Ball cover PCS.: 1  |
| | Pos. 8 Bolt 8,8 B M12x70mm PCS.: 1  | Pos. 14 Plain washer ø10mm PCS.: 6  | |
| Pos. 3 Tow ball PCS.: 1  | Pos. 9 Bolt 8,8 B M10x130mm PCS.: 2  | Pos. 15 Spring washer ø12mm PCS.: 2  | |
| | Pos. 4 Socket plate PCS.: 1  | Pos. 10 Bolt 8,8 B M10x40mm PCS.: 4  | Pos. 16 Spring washer ø10mm PCS.: 9  |



PPUH AUTO-HAK S.J.

Produkcja Haków Holowniczych
Henryk & Zbigniew Nejman
76-200 SŁUPSK ul. Słoneczna 16K
tel/fax (059) 8-414-414; 8-414-413
E-mail: office@autohak.com.pl
www. autohak.com.pl

Towing hitch (without electrical set)

Class: **A50-X** Cat. no. **E14**

Designed for:

Manufacturer: **OPEL**

Model: **OMEGA "A"**

Type: **4 doors**

produced since 1986 till 1993

Technical data:

D-value: 9,65 kN

maximum trailer weight: **1850 kg**

maximum vertical cup load: **75 kg**

Approval number acc. to regulations EKG/ONZ 55.01: **E20-55R-01 1169**

Foreword

This towbar is designed according to rules of safety traffic regulations. The towing hitch is a safety component and can be install only by qualified personnel. Any alteration or conversion of the towing hitch is prohibited and would lead to cancellation of design certification. Remove insulating compound and underseal from vehicle (if present) in the area of the matting surfaces of the towing hitch.

The vehicle manufacturer's specifications regarding trailer load and max. vertical cup load are decisive for driving whereat values for the towing hitch cannot be exceeded.

D-value formula:

$$\frac{\text{Max trailer weight [kg]} \times \text{Max vehicle weight [kg]}}{\text{Max trailer weight [kg]} + \text{Max vehicle weight [kg]}} \times \frac{9,81}{1000} = D \text{ [kN]}$$