

## FITTING INSTRUCTION

Clamp mark in acc. with		Cables joining
ISO	PN	
1	L	Left directional lights
2	+	Rear fog lights
3	31	Ground
4	R	Right directional lights
5	58R	Right side parking lights
6	54	Stoplights
7	58L	Left side parking lights

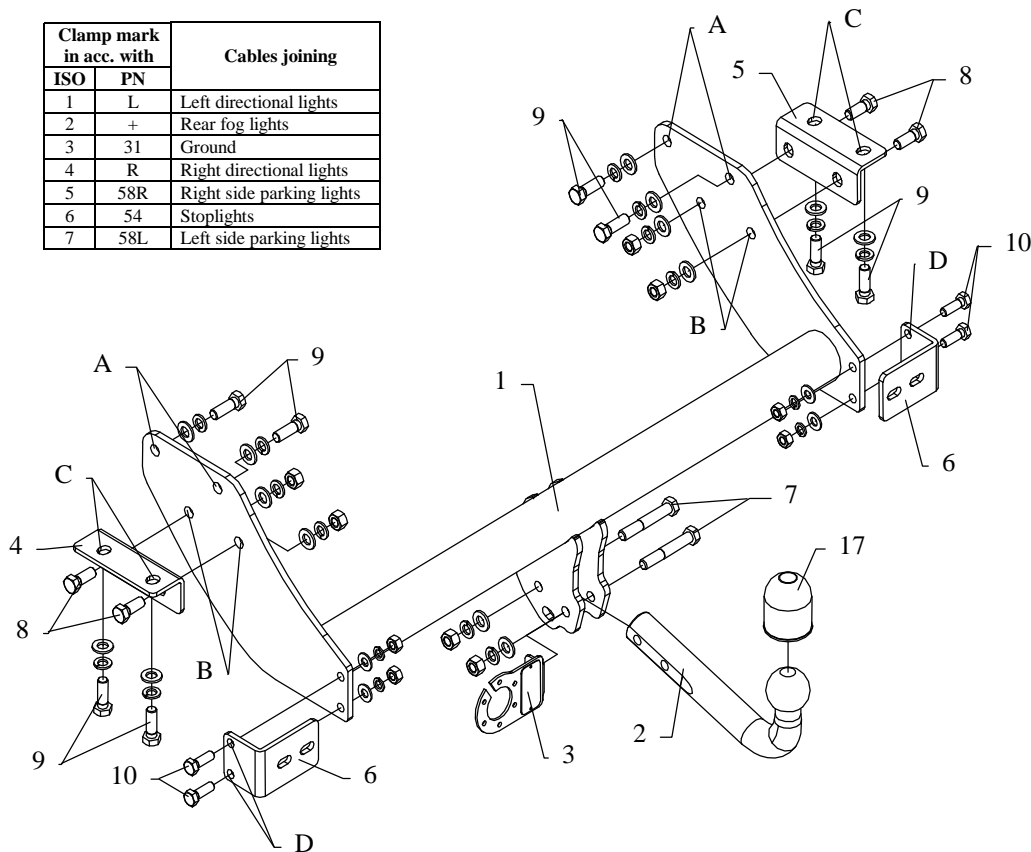

This towbar is designed to assembly in following cars:

**HYUNDAI H1** produced since 2005, catalogue number **J52** and is prepared to tow trailers max total weight **1600 kg** and max vertical load **75 kg**.

### *From manufacturer*

Thank you for buying our product. Their reliability has been confirmed in many tests. Reliability of towbar depends also on correct assembly and correct exploitation. For this reasons we kindly ask to read carefully this instruction and apply to hints.

*The towbar should be install in points described by a car producer.*

## The instruction of the assembly

1. To internal side of the car frame by original prepared and threaded holes (pos. A) fix main bar of the towbar (pos. 1) using bolts M12x1,25x35mm (pos. 9).
2. Through holes pos. B fix angle elements (pos. 4 and 5) using bolts M12x35mm (pos. 8), next through holes pos. C fix it to the frame of the car using bolts M12x1,25x35mm (pos. 9).
3. Through holes pos. D fix elements pos. 6 using bolts M10x30mm (pos. 10), next fix it to the bracket if the panel.
4. Fix the tow-ball (pos. 2) and socket plate (pos. 3) using bolts M12x75mm (pos. 7) from accessories.
5. Fix tight all bolts according to the torque shown in the table.
6. Connect electric wires according to the instruction of the car. (Recommend to make at authorized service station)
7. Complete the paint coating damaged during installation.

Torque settings for nuts and bolts (8,8):

<b>M 8</b>	25 Nm	<b>M 10</b>	55 Nm
<b>M 12</b>	85 Nm	<b>M 14</b>	135 Nm











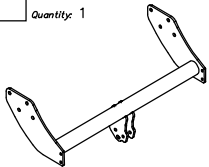



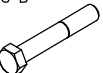

### NOTE

After install the towbar you should get adequate note in registration book (at authorised service station).The car should be equipped with:

- Indicators
- Tow mirrors

After 1000km check all bolts and nuts. The ball of towbar must be always kept clear and conserve with a grease.

## Towbar accessories:

Pos. 1 Name: Main bar Quantity: 1 	Pos. 5 Name: Right bracket Quantity: 1 	Pos. 10 Name: Bolt 8,8 B Quantity: 4 Dim.: M10x30mm 	Pos. 15 Name: Spring washer Quantity: 14 Dim.: $\phi$ 12,2 mm 
	Pos. 6 Name: Bracket Quantity: 2 	Pos. 11 Name: Nut 8 B Quantity: 6 Dim.: M12 	Pos. 16 Name: Spring washer Quantity: 4 Dim.: $\phi$ 10,2 mm 
Pos. 2 Name: Tow ball Quantity: 1 	Pos. 7 Name: Bolt 8,8 B Quantity: 2 Dim.: M12x75mm 	Pos. 12 Name: Nut 8 B Quantity: 4 Dim.: M10 	Pos. 17 Name: Ball cover Quantity: 1 
Pos. 3 Name: Socket plate Quantity: 1 	Pos. 8 Name: Bolt 8,8 B Quantity: 4 Dim.: M12x35mm 	Pos. 13 Name: Plain washer Quantity: 14 Dim.: $\phi$ 13 mm 	
Pos. 4 Name: Left bracket Quantity: 1 	Pos. 9 Name: Bolt 8,8 B Quantity: 8 Dim.: M12x1,25x35mm 	Pos. 14 Name: Plain washer Quantity: 4 Dim.: $\phi$ 10,5 mm 	



**PPUH AUTO-HAK S.J.**

Produkcja Haków Holowniczych  
Henryk & Zbigniew Nejman  
76-200 SŁUPSK ul. Słoneczna 16K  
tel/fax (059) 8-414-414; 8-414-413  
E-mail: office@autohak.com.pl  
www. autohak.com.pl

## Towing hitch (without electrical set)

Class: **A50-X** Cat. no. **J52**

Designed for:

Manufacturer: **HYUNDAI**

Model: **H1**

produced since 2005

Technical data:

**D-value: 10,77 kN**

maximum trailer weight: **1600 kg**

maximum vertical cup load: **75 kg**

Approval number according to Directive 94/20/EC: **e20\*94/20\*0056\*00**

## Foreword

This towbar is designed according to rules of safety traffic regulations. The towing hitch is a safety component and can be install only by qualified personnel. Any alteration or conversion of the towing hitch is prohibited and would lead to cancellation of design certification. Remove insulating compound and underseal from vehicle (if present) in the area of the matting surfaces of the towing hitch.

The vehicle manufacturer's specifications regarding trailer load and max. vertical cup load are decisive for driving whereat values for the towing hitch cannot be exceeded.

*D-value formula:*

$$\frac{\text{Max trailer weight [kg]} \times \text{Max vehicle weight [kg]}}{\text{Max trailer weight [kg]} + \text{Max vehicle weight [kg]}} \times \frac{9,81}{1000} = D \text{ [kN]}$$